

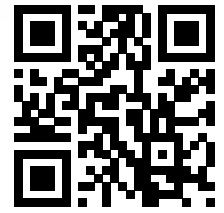





SD SERIES

<http://tiny.cc/7SDseriesEN>

NEW

| | | | | |
|---|---|--|---|---|
|  TIPPING LOAD 1610* kg |  ENGINE POWER 40* hp |  SPEED 17* km/h |  FLOW RATE 37* l/min |  LIFT HEIGHT 2,9 m |
|---|---|--|---|---|

(*) 8.4SD

| Model | 6.3 SD | 7.3 SD | 8.4 SD |
|---|---------------------------------------|---------------------------------------|---------------------------------------|
| Engine | Yanmar 3TNV76 | Yanmar 3TNV82 | Yanmar 3TNV88 |
| Power (Iso Gross) | 28 HP | 35 HP | 40 HP |
| Fuel | Diesel | | |
| Transmission | Hydrostatic | | |
| Drive speed (max.) - 2 speed | 14 km/h (8.7 mph) | 15 km/h (9.3 mph) | 17 km/h (10.5 mph) |
| Aux. hydraulics oil flow | 31 l/min (8.2 gal/min) | 37 l/min (9.8 gal/min) | 37 l/min (9.8 gal/min) |
| Max. lifting height | 2,90 m (114 in) | | |
| Tipping load, max ⁽¹⁾ | 1500 kg (3307 lbs) | 1580 kg (3483 lbs) | 1610 kg (3549 lbs) |
| Lifting capacity straight ⁽²⁾ | 1200 kg (2645 lbs) | 1260 kg (2778 lbs) | 1290 kg (2844 lbs) |
| Lifting capacity fully articulated ⁽³⁾ | 900 kg (1984 lbs) | 1100 kg (2425 lbs) | 1230 kg (2712 lbs) |
| Breakout force / 50 cm | 1400 kg (3086 lbs) | 1700 kg (3748 lbs) | 1700 kg (3748 lbs) |
| Pushing force (c) | 1000 kgf (1000 kp) | 1200 kgf (1200 kp) | 1200 kgf (1200 kp) |
| Specific ground pressure (w/standard tires) | 1113 kg/m ² (228 lbs/sqft) | 1175 kg/m ² (240 lbs/sqft) | 1230 kg/m ² (252 lbs/sqft) |
| Turning radius: inside/outside | 825/2090 mm (32.5/82.3 in) | | |
| Standard tires (Tractor profile) | 23X8.50-12 | 23X10.50-12 | 26X12.00-12 |
| Weight | 1610 kg (3549 lbs) | 1700 kg (3748 lbs) | 1780 kg (3924 lbs) |
| Product Code | C967000 | C967100 | C967200 |
| Price | | | |

(¹) Maximum load that can be lifted just off the ground when the machine is straight, with backweights and boom not extended. Weight of attachment included.

(²) Machine straight, with backweights and boom not extended. Weight of attachment is included. (80% of tipping load).

(³) Machine fully articulated, with backweights and boom not extended. Weight of attachment is included.

SD SERIES FEATURES AND OPTIONS

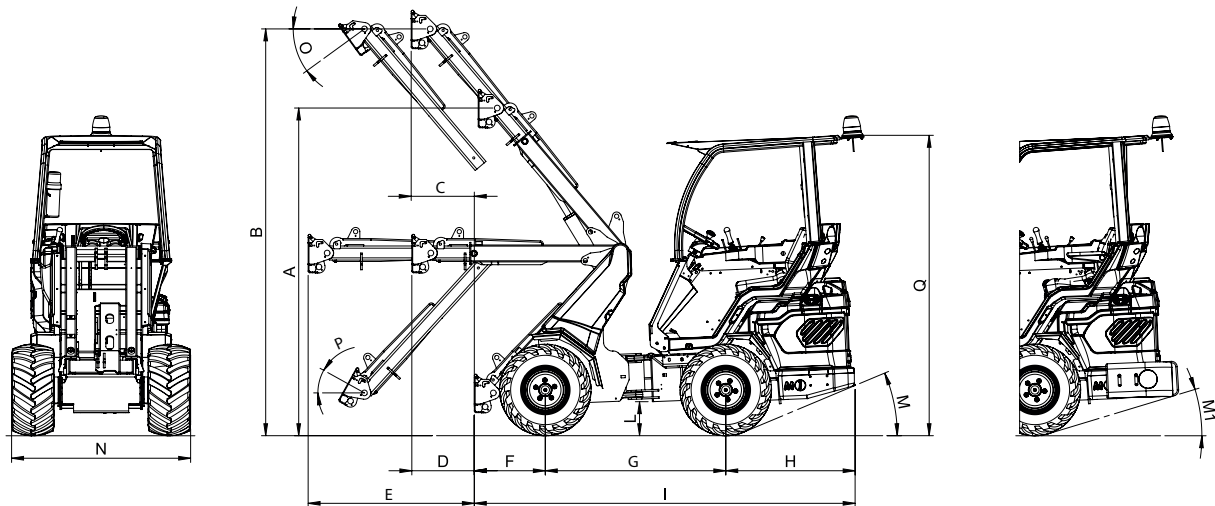

DIMENSIONS (mm / in)

| | | | |
|--|-------------|---|--------------|
| A - Pivot point height (not extended boom) | 2290 / 90 | I - Machine length | 2690 / 105.9 |
| B - Pivot point height (extended boom) | 2900 / 114 | L - Ground clearance | 210 / 8.3 |
| C - Outreach with lifted boom (extended boom) | 455 / 17.9 | M - Angle of departure (with/without backweights) | 15°/21° |
| D - Outreach with horizontal boom (not extended) | 445 / 17.5 | N - Max width (with standard tires) | 1130 / 44.5 |
| E - Outreach with horizontal boom (extended) | 1185 / 46.6 | O - Dump angle | 36° |
| F - Front length | 500 / 19.7 | P - Rollback angle | 29° |
| G - Wheelbase | 1280 / 50.4 | Q - Height (with standard tires) | 2100 / 82.7 |
| H - Rear length | 910 / 35.8 | | |

Features

- Telescopic boom, double-H frame
- 4WD hydrostatic Direct Drive motors
- DBS (Dynamic Block System) - option
- Torque divider - option
- Self-levelling boom - option
- 4-functions joystick
- Hydraulic oil cooler
- Hydraulic multiconnector
- ROPS-FOPS Level I
- LCD graphic display with programmed service (tachometer, hour meter, fuel gauge, maintenance light, light indicator and other 14 indicators)
- 2 front working light
- Ergonomic full adjustable spring seat with armrests and safety belt
- Ready to fit cabin

| Tires size | Width (N) | Height (Q) |
|-------------|-------------------|-------------------|
| 26X12.00-12 | 1300 mm (51.2 in) | 2140 mm (84.2 in) |
| 27X10.50-15 | 1150 mm (45.3 in) | 2180 mm (85.8 in) |
| 23X10.50-12 | 1130 mm (44.5 in) | 2100 mm (82.7 in) |
| 27X8.50-15 | 1070 mm (42.1 in) | 2180 mm (85.8 in) |
| 23X8.50-12 | 1070 mm (42.2 in) | 2100 mm (82.7 in) |

SD SERIES - FEATURES AND OPTIONS

| Options | Code | Price |
|--|-------------|-------|
| Hi-Flow | C883054 | |
| Torque divider | C883004 | |
| Floating boom valve | C883011 | |
| Luxury cabin (glass) | C883044 | |
| Heating system 6.3 SD | C883602 | |
| Heating system 7.3 SD | C883701 | |
| Heating system 8.4 SD | C883803 | |
| Plexiglass windscreen (smart cabin) | C883046 | |
| Plexiglass right side (smart cabin) | C883034 | |
| Plexiglass back window (smart cabin) | C883035 | |
| Led Road lights "Hella" | C883045 | |
| 3 additional working led light "Hella" | C883018 | |
| Automatic locking plate | C883051 | |
| Attachment coupling plate for rear mounting | C880031 | |
| Multiconnector to quick coupling 3 lines adapter | C880221 | |
| Trailer coupling | C885014 | |
| Additional backweights (184 kg / 406 lbs) | C880054 | |
| Back up alarm | C883021 | |
| "Luxury" heated seat | C883006 | |
| 220 V engine block heater | C885250 | |
| 110 V engine block heater | C885255 | |
| Left protection bar for operator | C883052 | |
| Rear 12V electric socket | C883050 | |
| Rear hydraulic outlets - single | C883049 | |
| Rear hydraulic outlets - double | C883048 | |
| Additional front hydraulic outlets | C883055 | |
| Wheel spacer 10 mm (0.2 in) (max. 1 pcs for wheel) | C880090 | |
| Wheel spacer 55 mm (2.2 in), set of 4 | C885010 | |
| Biodegradable oil | C883007 | |
| Snow chains for wheel | see page 57 | |
| Driver area cover | C880049 | |
| Available tires | see page 50 | |
| Beacon light | C883039 | |
| Air conditioning (only 8.4 SD) | C883804 | |
| DBS (Dynamic Block System) | C883042 | |
| Self levelling system 6.3 SD | C883604 | |
| Self levelling system 7.3 SD and 8.4 SD | C883043 | |
| Drive motors power kit 6.3 SD | C883603 | |
| Drive motors power kit 7.3 SD and 8.4 SD | C883040 | |
| 9 - function joystick | C883041 | |